

TONAVA, akciová společnost



ELEKTRONICKÉ VÁHY CAMPESA

PROPOJOVACÍ KABELY

VÁHY - PC

TECHNICKÁ PŘÍRUČKA

Úvod

Tento dokument není překladem žádné publikace firmy Campesa.

Je souborem schémat propojovacích kabelů mezi vahami a PC, která byla získána během školení. Nemusí být svým obsahem vyčerpávající.

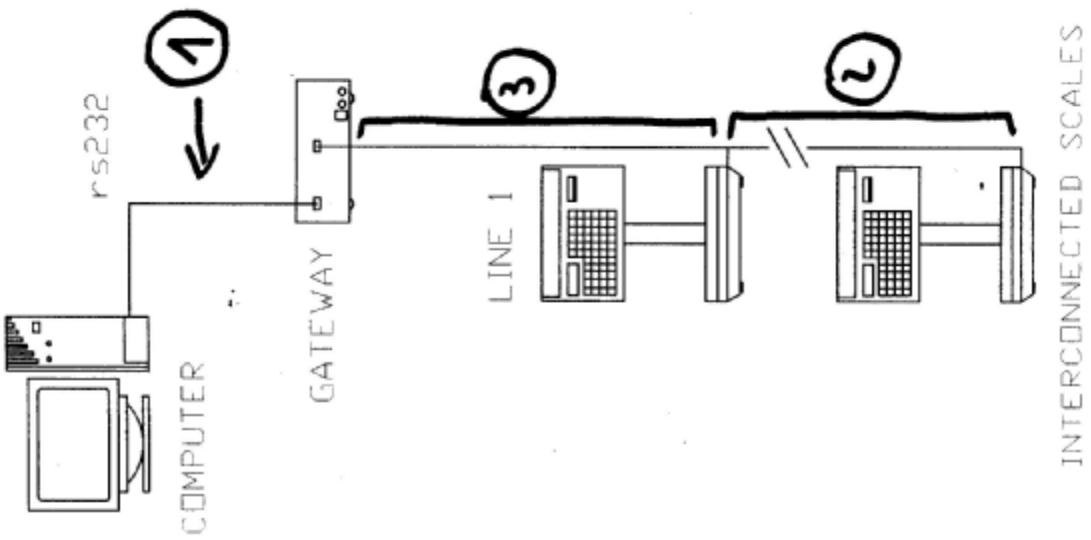
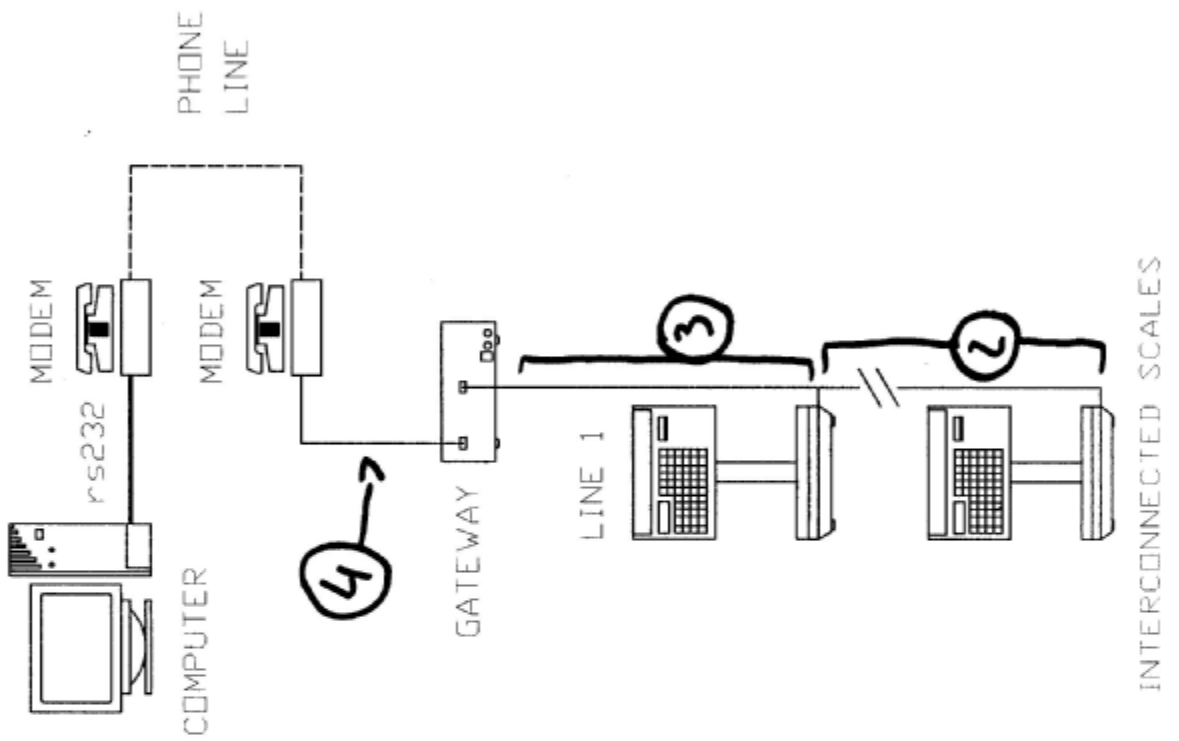

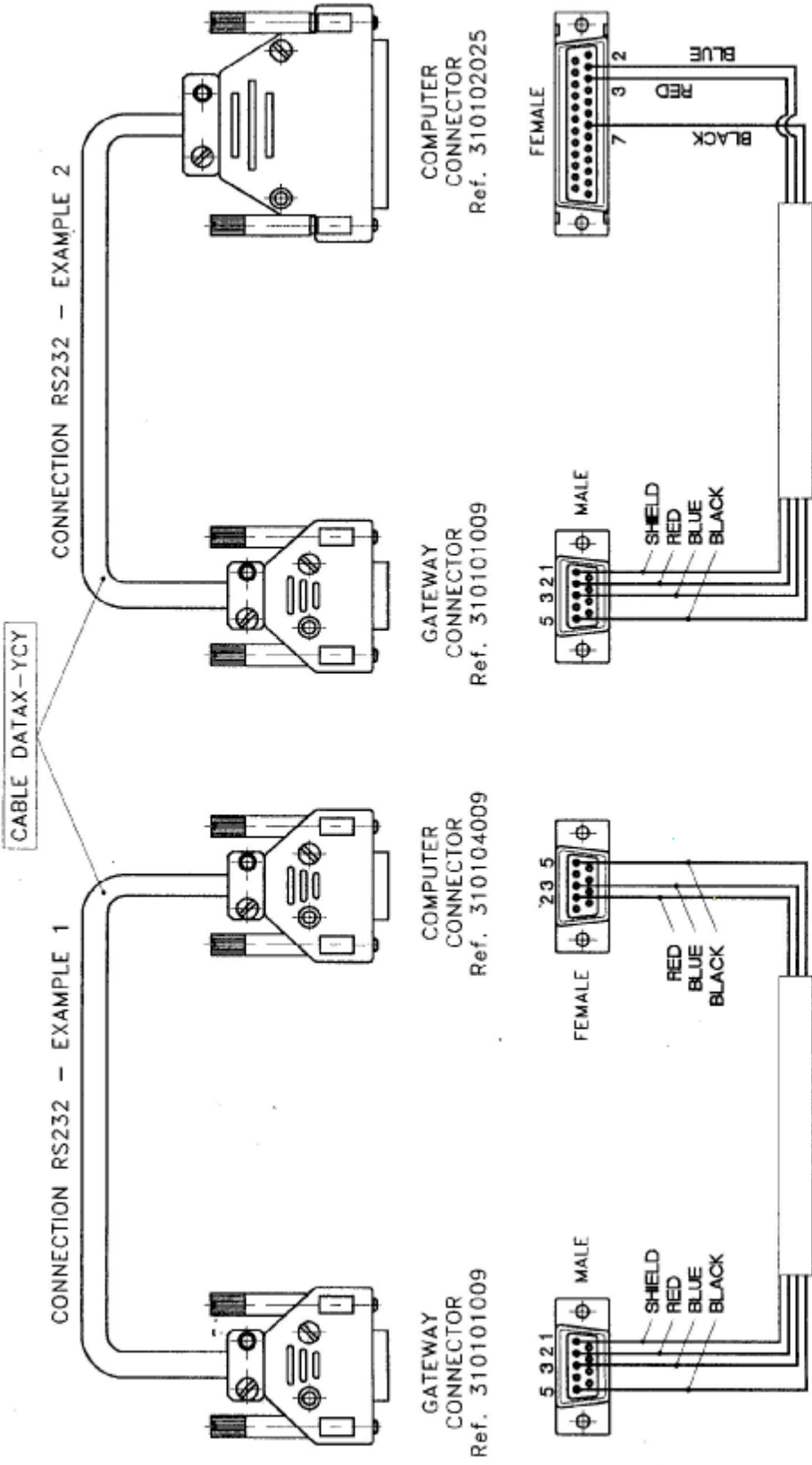

CONNECTORS SIGHT FROM THE SOLDERSIDE

NOTE:

- The contacts with soldered cables are protected with a thermoretractil tube.
- Example 1: Connectors of 9c.
- Example 2: Gateway-connector of 9C and computer connector of 25C.

MODELO	65.110/3	DESCRIPCION	DETAL DE LA CONEXION DE LA EXTERNAL CABLE BETWEEN THE GATEWAY AND THE COMPUTER						
RE		DESEÑADO	FECHA	NOMBRE	ESCALA				
SUSTITUYE A		REVISADO	26-11-01	SPEZEL					
SUSTITUIDO POR:									
VALIDEZ					NO FIRMADO				
1	2	3	4	5	6	7	8	9	10
11	12	13	14	15	16	17	18	19	20
Campesa S.A.					REF	1242145			

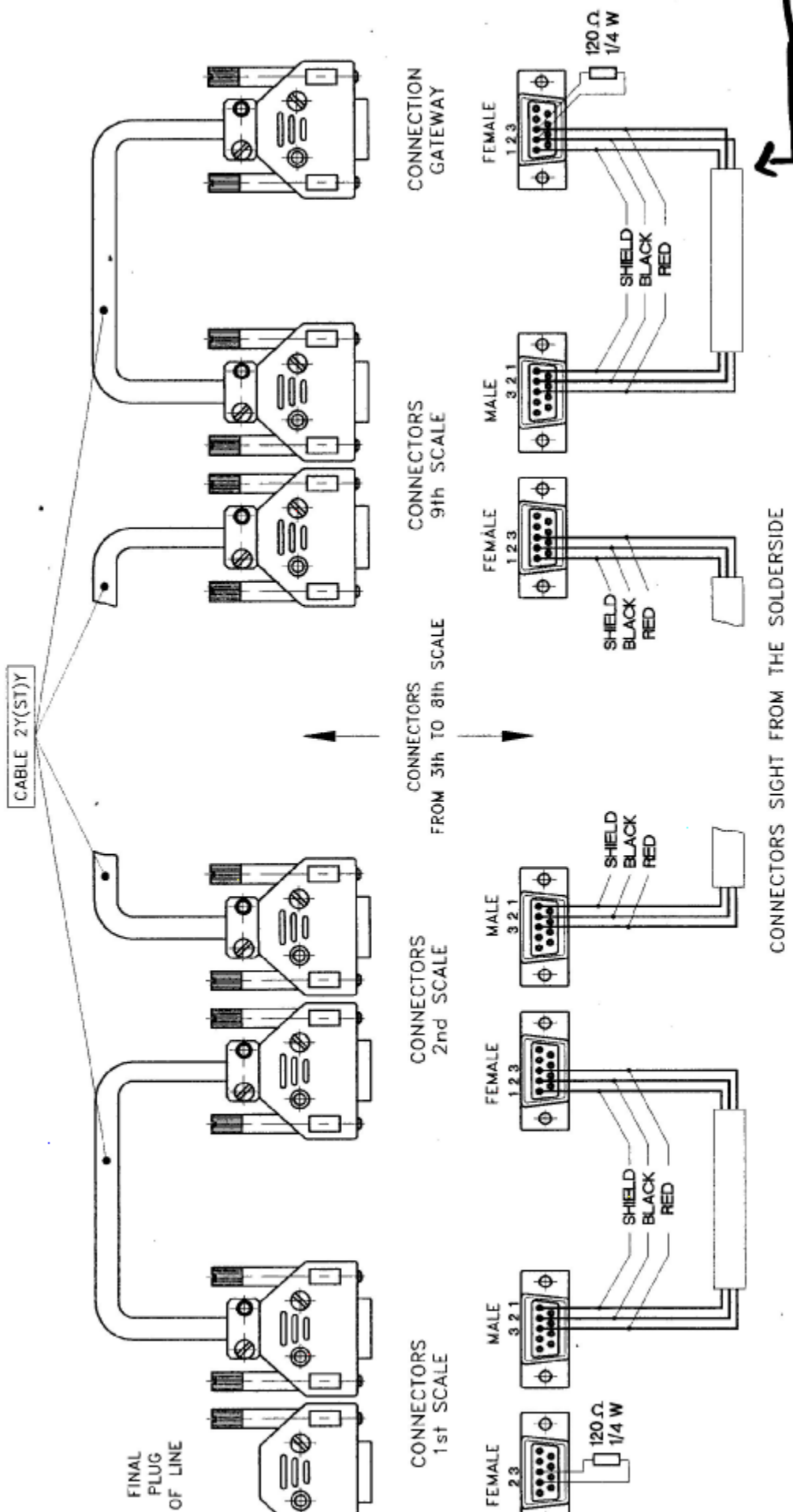

CONNECTORS SIGHT FROM THE SOLDERSIDE

NOTE:

- Interconnection cables with connectors of 9C one male Ref. 310101009 and another female Ref. 310104009.
- The resistance of 120Ω/4 W will be placed in the final plugs of the line.
- The contacts with soldered cables will be protected with a thermoretractil tube.

MODELLO	65110/3 CE		
DESCRIZIONE	DETAIL OF THE CONNECTION OF THE EXTERNAL CABLES BETWEEN SCALE AND GATEWAY		
RC	FECHA	NOMBRE	ESCALA
SUBSTITUTE A:	DISEÑADO	26-11-01	SPERZ
SUBSTITUIDO POR:	REVISADO	26-11-01	L. ALBES
VALIDZ	NO PLANO		
	11	12	13
	14	15	16
	17	18	19
	20		

Campepa s.a.

REF. 1242147

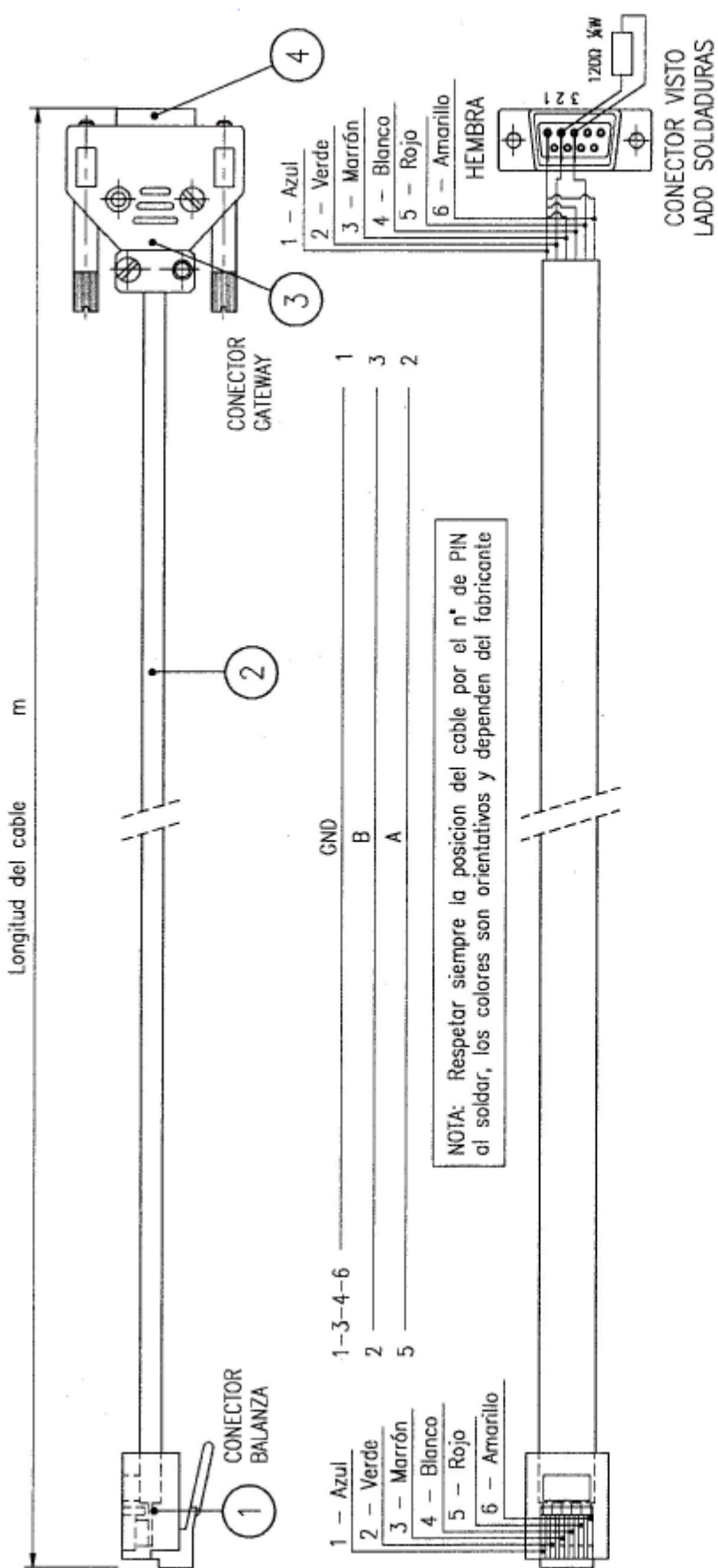

- Los contactos con cables soldados se protegerán mediante tubo termoretráctil.

- 1.- CONECTOR TELEFONICO MACHO MODULAR 6P 6C (RJ11) CODIGO "ARISTON" C1066
- 2.- CABLE MANGUERA PLANA PARA TELEFONIA 6 VAS COLOR NEGRO CODIGO "ARISTON" MT6N 6x6x0,15
- 3.- CAPERUZA POUJAIN 9 CON TORNILLOS
- 4.- CONECTOR POUJAIN DN 9 SZ (HEMBRA)

1		Incluir denominación de conector de Balanza y de Gateway		S. Pérez	L. Albes	02-07-01
0						
REV. 01		MODIFICACIONES		DELIBADO	REVISADO	FECHA
SUSTITUYE A:		SUSTITUIDO POR:		RE. 500-00101922	CAUFACION	3B
NO PEZAS		MATERIAL		MODELO AUTONOMA 30		
EDIAS SIN TOLERANCIA		TRATAMIENTO		CJTD. CABLE INTERCONEXION		
0 < 10				ENTRE BALANZAS Y GATEWAY (RJ11-089)		
> 10 < 50				FECHA	NOMBRE	ESCALA
> 50 < 100				DELIBADO	8-6-00	L. Durán
> 100				REVISADO	8-6-00	L. Albes
ANGULOS		RUGOSIDAD		NO PLANO		
X X X		VVVV 0.1 Ra MAX				
X X X		VVVV 0.5 Ra MAX				
X X X		VV 0 Ra MAX				



REF. 500101927

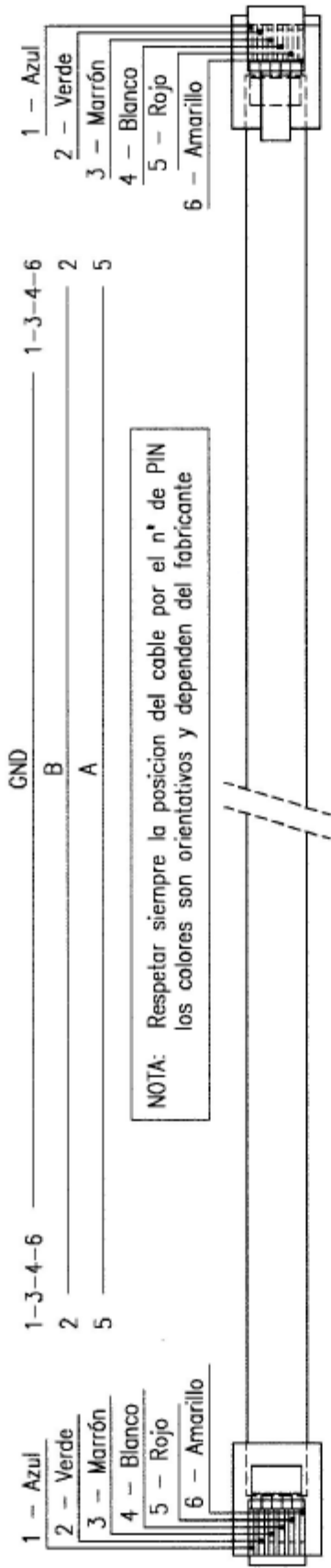
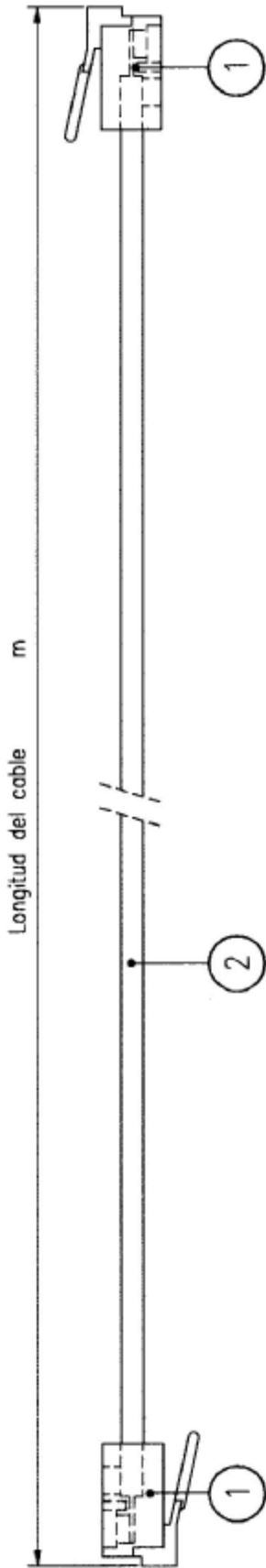

- 1.- CONECTOR TELEFONICO MACHO MODULAR 6P 6C (RJ11)
CODIGO "ARISTON" CT066
- 2.- CABLE MANGUERA PLANA PARA TELEFONIA 6 VMS COLOR NEGRO
CODIGO "ARISTON" MT6N 6x6x0,15

SE ANDE NOTA Aclaración colores de cables		L. Durón	L. Albes	26-5-00	
MODIFICACIONES					
SUSTITUYE A:	SUSTITUIDO POR:	RC.	500-00101915	CAIFACION	3B
s/despiece	s/despiece	MODELO			BASIC PRINT
NO PIEZAS		TRATAMIENTO		CABLE INTERCONEXION ENTRE BALANZAS	
COTAS SIN TOLERANCIA					
0 < B	* 01				
> B < 50	* 02				
> 50 < 120	* 03				
> 120	* 05				
ANGULOS		RUGOSIDAD			
R X X'	R	01	02	03	05
X X'	P	01	02	03	05
X	T	01	02	03	05
NO PLANO					REF. 500101915
Campepa s.a.					ESCALA 2 : 1

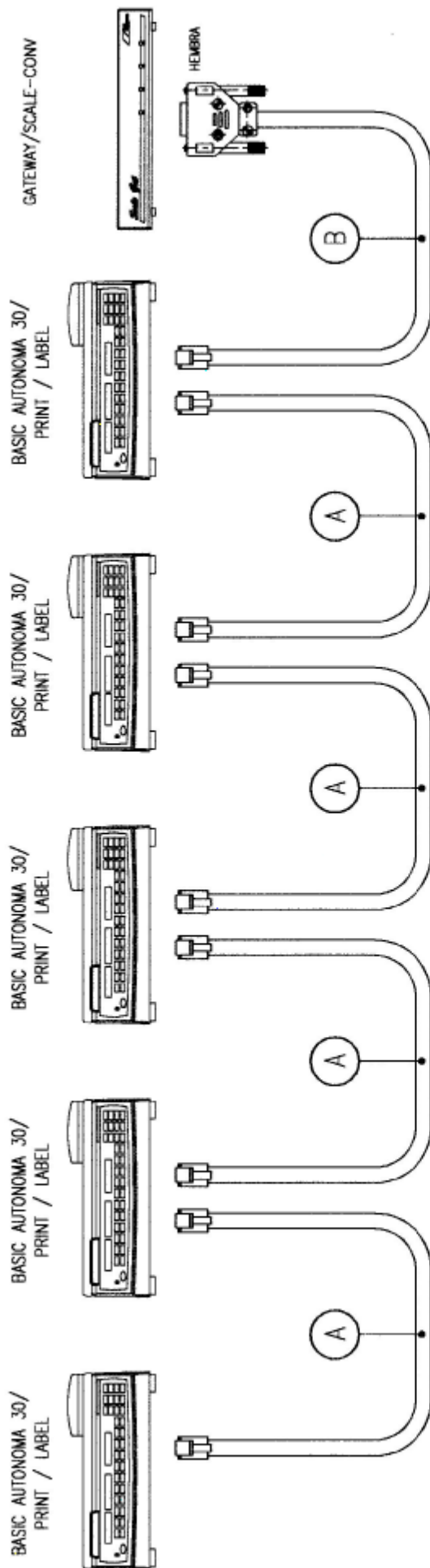

- A.- C.JTO. CABLE ENTRE BALANZAS REF. 500101915
- B.- C.JTO. CABLE ENTRE BALANZAS Y GATEWAY (Rj11-DB9) REF. 500101927

Actualización de modelos de balanzas		S. Pérez	L. Albes	02-07-01
MODIFICACIONES		0	0	0
SUSTITUYE A.		SUSTITUIDO POR:		FECHA
NO PREZAS		MATERIAL		CALEFACION
COTIAS SIN TOLERANCIA		TRATAMIENTO		MODELO
0 < 18		INTERCONEXIONES ENTRE BALANZAS BASIC GATEWAY		AUTONOMA 30, PRINT, LABEL
> 18 < 50		FECHA		ESCALA
> 50 < 100		9-6-00		9-6-00
> 100		9-6-00		9-6-00
ANGULOS		RUGOSIDAD		NO PLANO
X X X		VVVV		0.1 Ra MAX
X X X		VV		0.5 Ra MAX
X		VV		8 Ra MAX

CampeSA s.a.

REF. 1247915

BASIC PRINT

BASIC AUTONOMA 30

BASIC PRINT

BASIC AUTONOMA 30

BASIC PRINT

BASIC AUTONOMA 30

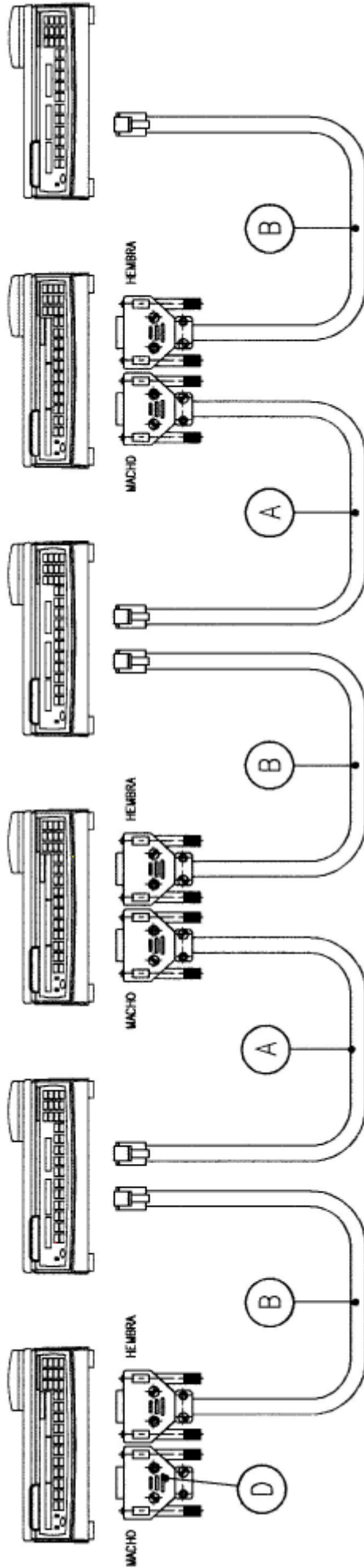

- A.- C.JTO. CABLE ENTRE BALANZAS (DB9-RJ11) REF. 500101921
- B.- C.JTO. CABLE ENTRE BALANZAS (RJ11-DB9) REF. 500101922
- D.- TAPON FINAL DE LINEA REF. 500101744

MODIFICACIONES		REVISIONES	
NO. PEZAS	MATERIAL	TRATAMIENTO	MODELO
COTAS SIN TOLERANCIA			
0 < 10	+ 0.1		
> 10 < 50	+ 0.2	FECHA	ESCALA
> 50 < 120	+ 0.3	HEMBRA	30-5-00
> 120	+ 0.5	REVISADO	30-5-00
ANGULOS		RUGOSIDAD	
° X °	+ 0.30	VVVV	0.1 Ra MAX
° X °	+ 0.5	VVV	0.5 Ra MAX
° X °	+ 1	VV	1 Ra MAX
		NO PLANO	
		REF. 124.1905	

Campesa s.a.

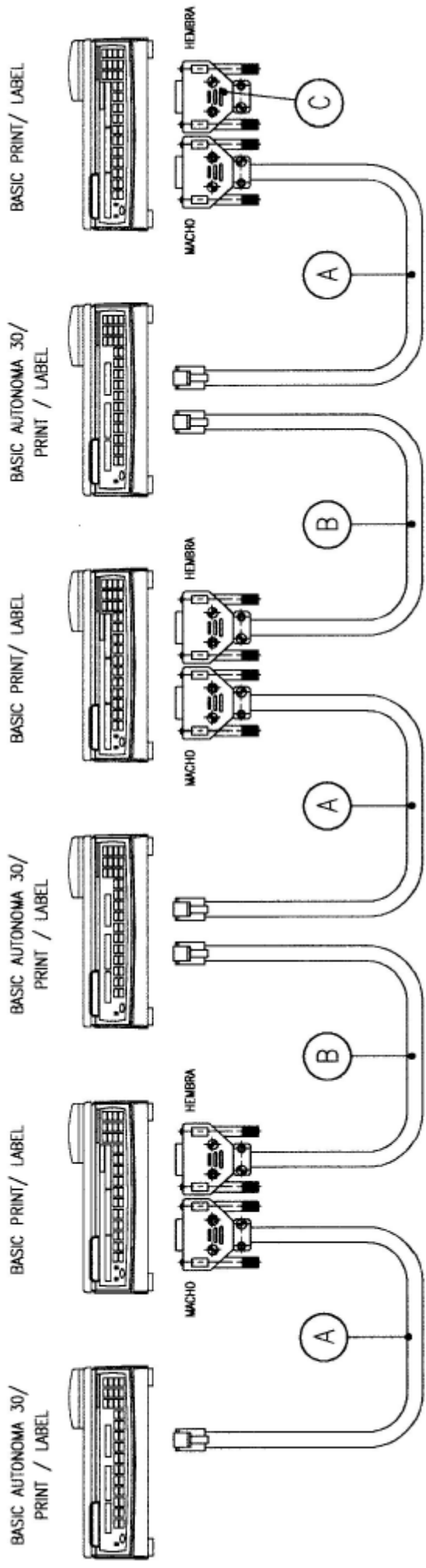

- A.- CUITO. CABLE ENTRE BALANZAS (DB9-RJ11) REF. 500101921
- B.- CUITO. CABLE ENTRE BALANZAS (RJ11-DB9) REF. 500101922
- C.- TAPON PRINCIPIO DE LINEA REF. 500101742

Actualización de modelos de balanzas.		S. Perez	L. Albes	02-07-01
MODIFICACIONES		DEBUNDO	REVISADO	FECHA
SUSTITUYE A:	SUSTITUIDO POR:	RC.	CALIFICACION	
NO PEZAS	MATERIAL	TRATAMIENTO		MODELO
CONDICIONES SIN TOLERANCIA		DENOMINACION		AUTONOMA 30, PRINT, LABEL
0 < 98	* 0.1	INTERCONEXIONES ENTRE BALANZAS BASIC		RS-485
> 98 < 50	* 0.2	FECHA	ESCALA	
> 50 < 20	* 0.3	DEBUNDO	30-5-00	L. Durán
> 20	* 0.5	REVISADO	30-5-00	L. Albes
ANGULOS	RUEGOSIDAD	NO PLANO		
X X X	* 0.30			
X X X	* 0.5			
X X X	* 1			



REF. 1241904

CABLE DATAX-YCY

CONNECTION RS232 - EXAMPLE 1

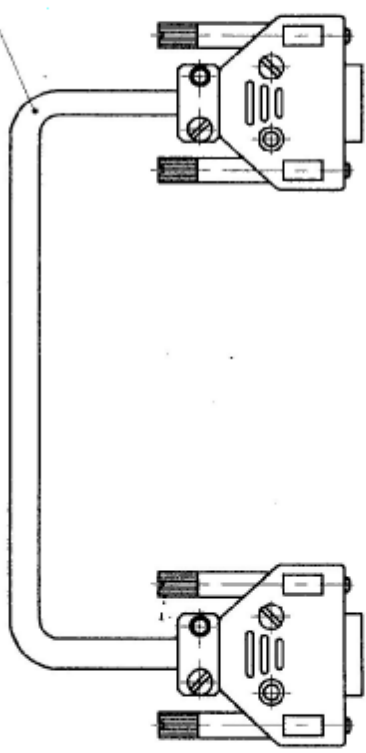

GATEWAY CONNECTOR
Ref. 310101009

COMPUTER CONNECTOR
Ref. 310104009

CONNECTION RS232 - EXAMPLE 2

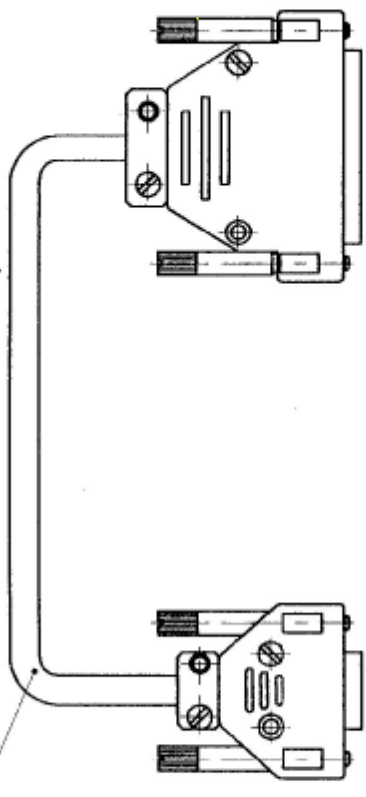

GATEWAY CONNECTOR
Ref. 310101009

COMPUTER CONNECTOR
Ref. 310102025

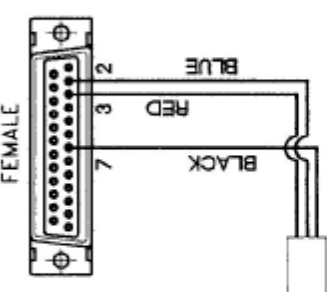
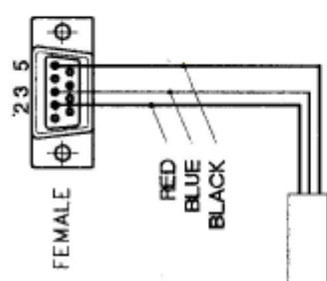
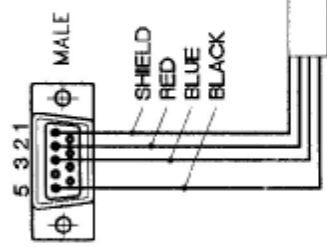

CONNECTORS SIGHT FROM THE SOLDERSIDE

NOTE:

-The contacts with soldered cables are protected with a thermoretracil tube.

-Example 1: Connectors of 9c.

-Example 2: Gateway-connector of 9C and computer connector of 25C.

MODELO	65110/3	DENOMINACION			DETALLE DE LA CONEXION DE LA EXTERNA				
RC		DEBILIDAD	FECHA	NUMERO	CABLE ENTRE EL GATEWAY Y EL COMPUTADOR				
SUSTITUYE A		REVISADO	26-11-01	5 PEREZ	ESCALA				
SUSTITUIDO POR									
VALIDEZ					NO PLANO				
1	2	3	4	5	6	7	8	9	10
11	12	13	14	15	16	17	18	19	20
				CampeSA s.a.		REF.		1242145	

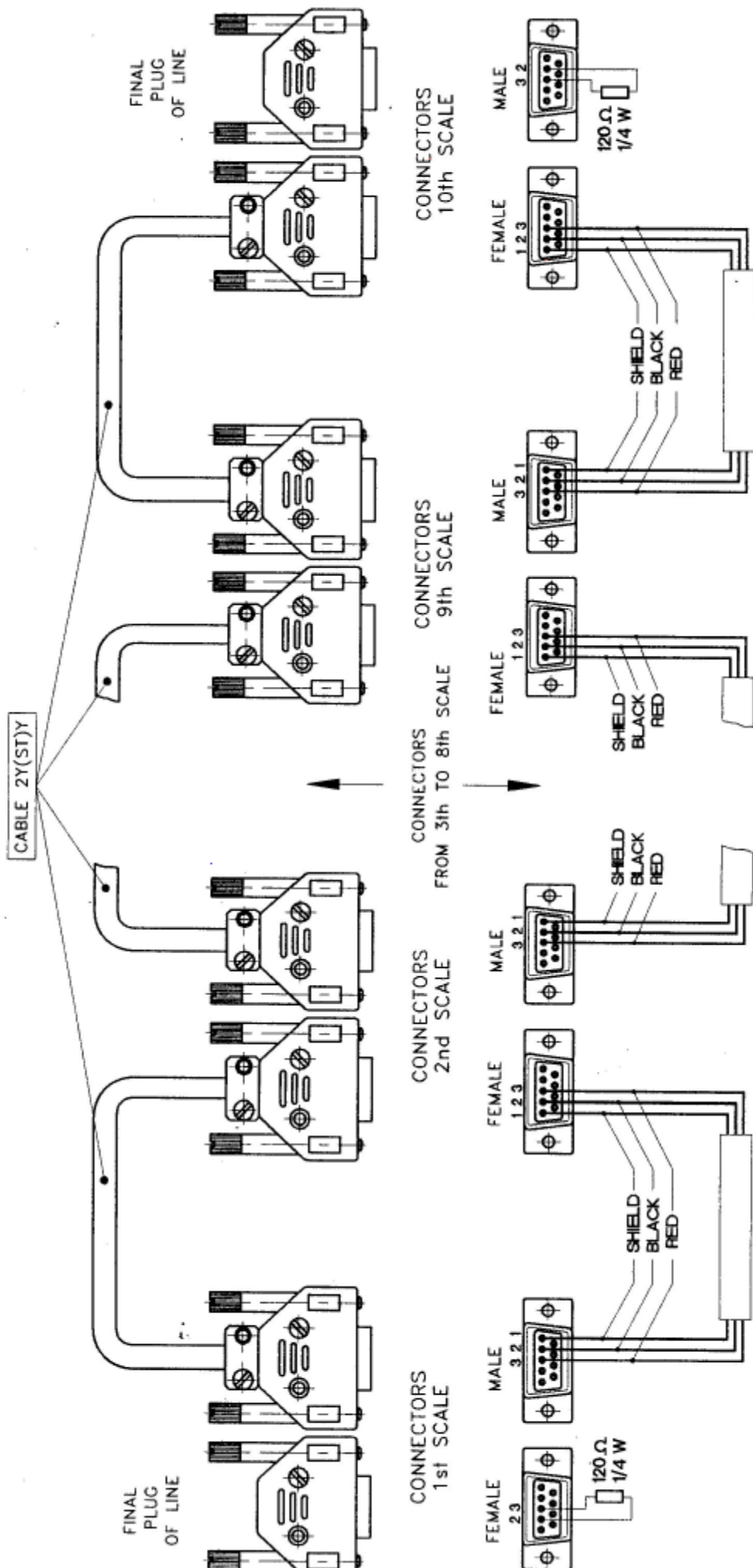

CONNECTORS SIGHT FROM THE SOLDER SIDE

NOTE:

- Interconnection cables with connectors of 9C one male Ref. 310101009 and another female Ref. 310104009.
- The resistance of 120 Ohm 1/4 W will be placed in the final plug of female line and in the female connector of the gateway.
- The contacts with soldered cables will be protected with a thermoretractil tube.

MODEL	65110/3 CE	DENOMINACION DETAIL OF THE CONNECTION EXTERNAL CABLES BETWEEN INTERCONNECTED SCALES		
R.C.		FECHA	NUMBRE	ESCALA
SUSTITUYE A		DELIJADO	26-11-01	S PEREZ
SUSTITUIDO POR		REVISADO		
VALORES				
<input checked="" type="checkbox"/>	2	<input type="checkbox"/>	3	<input type="checkbox"/>
<input type="checkbox"/>	4	<input type="checkbox"/>	5	<input type="checkbox"/>
<input type="checkbox"/>	6	<input type="checkbox"/>	7	<input type="checkbox"/>
<input type="checkbox"/>	8	<input type="checkbox"/>	9	<input type="checkbox"/>
<input type="checkbox"/>	10	<input type="checkbox"/>	11	<input type="checkbox"/>
<input type="checkbox"/>	12	<input type="checkbox"/>	13	<input type="checkbox"/>
<input type="checkbox"/>	14	<input type="checkbox"/>	15	<input type="checkbox"/>
<input type="checkbox"/>	16	<input type="checkbox"/>	17	<input type="checkbox"/>
<input type="checkbox"/>	18	<input type="checkbox"/>	19	<input type="checkbox"/>
<input type="checkbox"/>	20			

CampeSA s.a.

NO PLANO

REF

12/42146

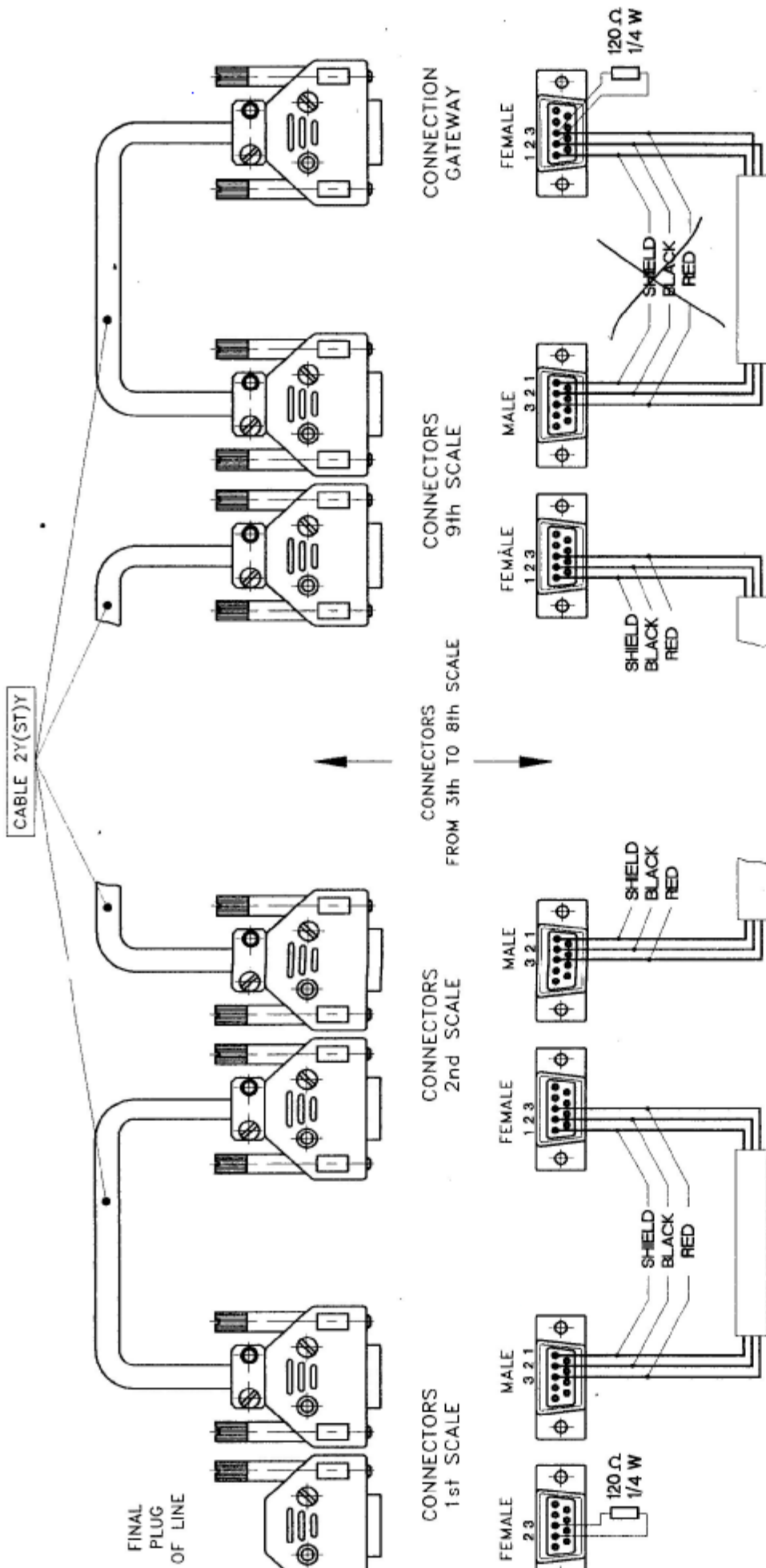

CONNECTORS SIGHT FROM THE SOLDERSIDE

NOTE:

- Interconnection cables with connectors of 9C one male Ref. 310101009 and another female Ref. 310104009.
- The resistance of 120Ω/4 W will be placed in the final plugs of the line.
- The contacts with soldered cables will be protected with a thermoretractil tube.

MODELLO	65110/3 CE		
RC	DESCRIZIONE	FECHA	NUMBRE
	SUBSTITUPE A:	26-11-01	SPEPEZ
	SUBSTITUPE POR:	26-11-01	LALBES
VALOR	NO P. AND		
X	3	4	5
X	6	7	8
X	9	10	11
X	12	13	14
X	15	16	17
X	18	19	20

Campepa s.a.

REF 1242147

POULAIN HOOD
25 WITH SCREW
Ref.-310103025

DATA CABLE-YCY 6x0,25 GREY
Ref.-210601008
LENGTH 2000 mm

POULAIN HOOD
25 WITH SCREW
Ref.-310103025

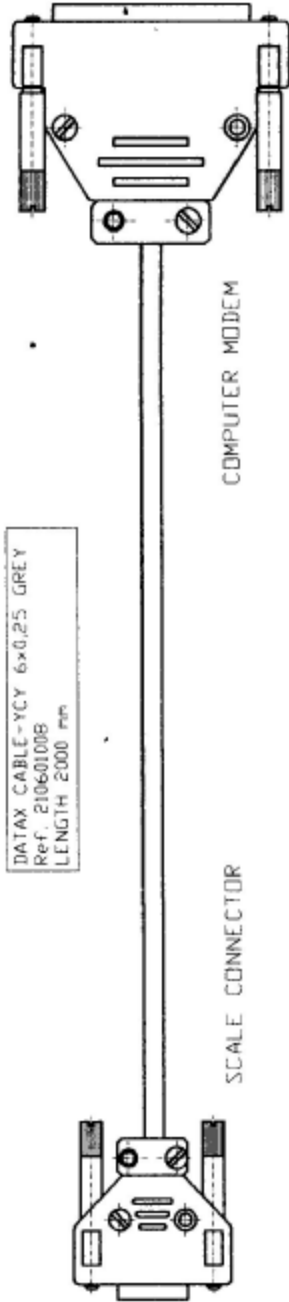

POULAIN CONNECTOR
DN 9 PZ (MALE)
Ref.-310101009

- 1 - SHIELD
- 2 - TXD (RED)
- 3 - RXD (BLUE)
- 5 - BLACK

CONNECTOR SIGHT
FROM SOLDESIDE

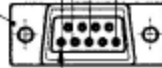

POULAIN CONNECTOR
DN 25 PZ (MALE)
Ref.-310101025

- 2 - RXD (RED)
- 3 - TXD (BLUE)
- 7 - BLACK

CONNECTOR SIGHT
FROM SOLDESIDE

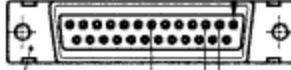

Note: The contacts with soldered cables will be protected with thermoretractil tube.

SUSTITUYE A		SUSTITUIDO POR		MODIFICACIONES		FECHA		NUMERO	
S/Despiece		RC 500-101876		S/Despiece		6511 G/3		3B	
MATERIAL		TRATAMIENTO		MODELO		DENOMINACION		ESCALA	
COTAS SIN TOLERANCIA		100M 4C RS-232 GATEWAY TO MODEM		9 Y 25 CONTACTOS		ESCALA		CONV.	
0 <= 6		+ 01		FECHA		NUMERO		CONV.	
> 6 <= 10		+ 02		26-11-01		S/Despiece		CONV.	
> 10 <= 50		+ 03		26-11-01		LALBELS		CONV.	
> 50 <= 120		+ 05		26-11-01		LALBELS		CONV.	
> 120		+ 1		26-11-01		LALBELS		CONV.	
ANGULOS		RUGOSIDAD		NO PLANO		REF		1242148	
X X X		0 3F		V V V		05 04 MAX		W W	
X X		0 5		V V		04 MAX		W W	
X		1 F		V V		04 MAX		W W	

Campeasa s.a.

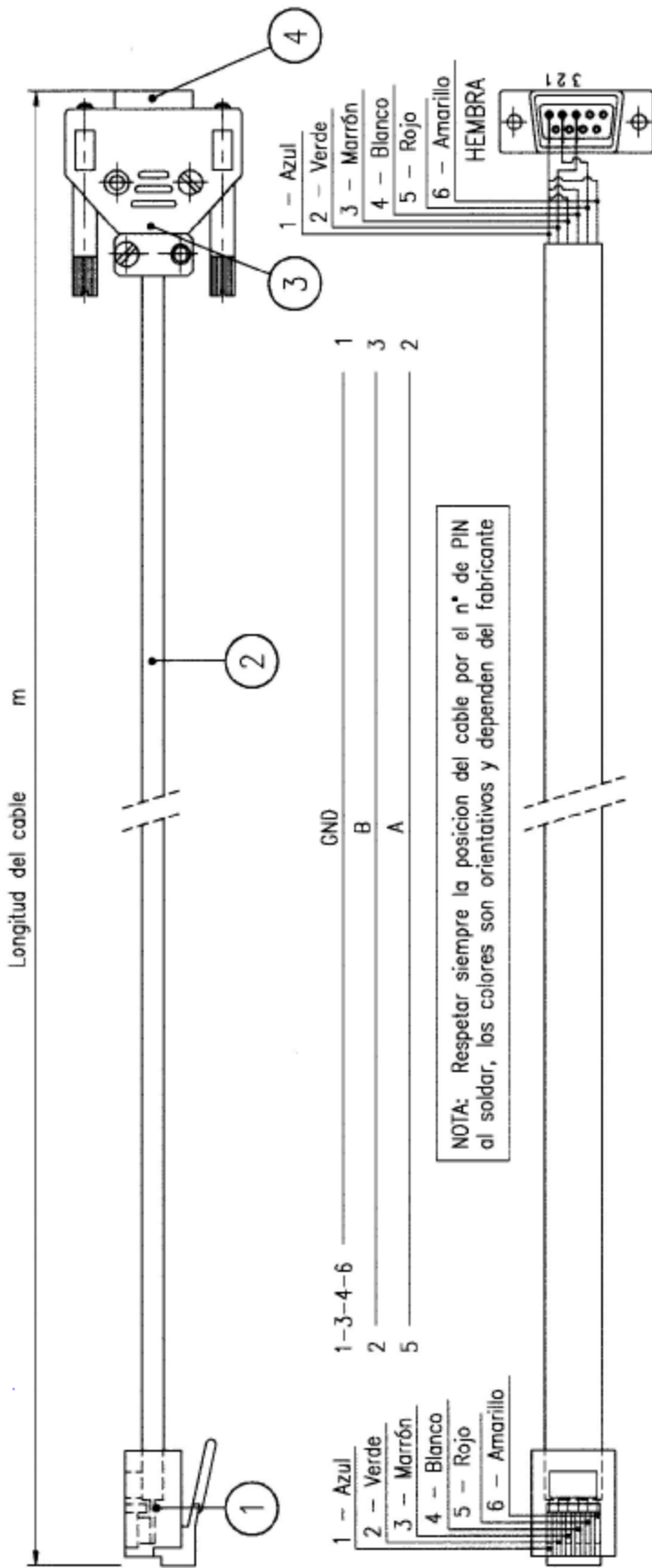

CONECTOR VISTO
LADO SOLDADURAS

- Los contactos con cables soldados se protegerán mediante tubo termoretráctil.

NO.	MODIFICACIONES	DEBILIDAD	REVISADO	FECHA
SUSTITUYE A:	SUSTITUIDO POR:	R.C.	500-00101922	CAIFICACION
				3B
NO PIEZAS	MATERIAL	TRATAMIENTO	MODELO	
			AUTONOMA 30	
CANTAS SIN TOLERANCIA		DENOMINACION		
CJTD. CABLE INTERCONEXION		ENTRE BALANZAS (RJ11-DB9)		
0 < 10	+ 01	FECHA	ESCALA	
> 10 < 50	+ 02	29-5-00	L. Durán	
> 50 < 100	+ 03	29-5-00	L. Durán	
> 100	+ 05	29-5-00	L. Aldres	
ANGULOS	RUGOSIDAD	NO PLANO		
X X X	XXXX 0.1 Ra MAX			
X X X	XXX 0.5 Ra MAX			
X	XX 1 Ra MAX			

Campesa s.a.

REF. 500101922

- 1.- CONECTOR TELEFONICO MACHO MODULAR 6P 6C (RJ11) CODIGO "ARISTON" CT066
- 2.- CABLE MANGUERA PLANA PARA TELEFONIA 6 MAS COLOR NEGRO CODIGO "ARISTON" MTGN 6x6x0,15
- 3.- CAPERUZA POUJAIN 9 CON TORNILLOS
- 4.- CONECTOR POUJAIN DN 9 SZ (HEMBRA)

Longitud del cable m

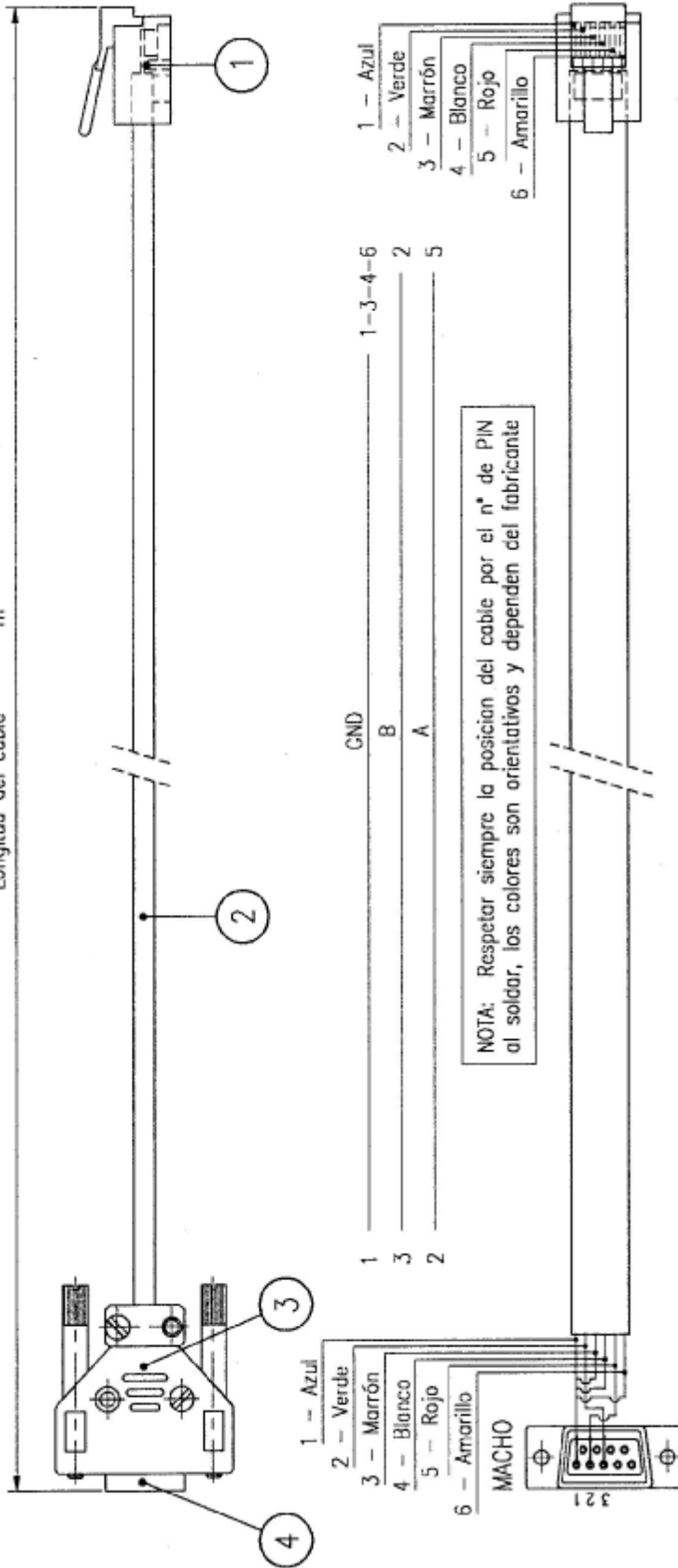

CONECTOR VISTO LADO SOLDADURAS

- 1.- CONECTOR TELEFONICO MACHO MODULAR BP 6C (RJ11) CODIGO "ARISTON" C1066
- 2.- CABLE MANGUERA PLANA PARA TELEFONIA 6 VAS COLOR NEGRO CODIGO "ARISTON" MTSN 6x6x0,15
- 3.- CAPERUZA POUJAIN 9 CON TORNILLOS
- 4.- CONECTOR POUJAIN DN 9 PZ (MACHO)

- Los contactos con cables soldados se protegerán mediante tubo termoretroctítil.

MODIFICACIONES		REVISIONES	FECHA
D			
NV			
SUSTITUYE A:		SUSTITUIDO POR:	RE. 500-00701921
S/DESPIECE		S/DESPIECE	
MATERIAL		TRATAMIENTO	MODELO
CITAS SIN TOLERANCIA		CONDICION	
0 < 98	+ 01	CJTO. CABLE INTERCONEXION	
> 98 < 50	+ 02	ENTRE BALANZAS (039-RJ11)	
> 50 < 20	+ 03	FECHA	ESCALA
> 20	+ 05	29-5-00	L. Durán
ANGULOS		REVISADO	L. Albes
0° 30'	0° 30'	NO PLANO	
0° 45'	0° 45'	REF. 500101921	
0° 15'	0° 15'	AUTONOMA 30	

Campesa s.a.

Longitud del cable m

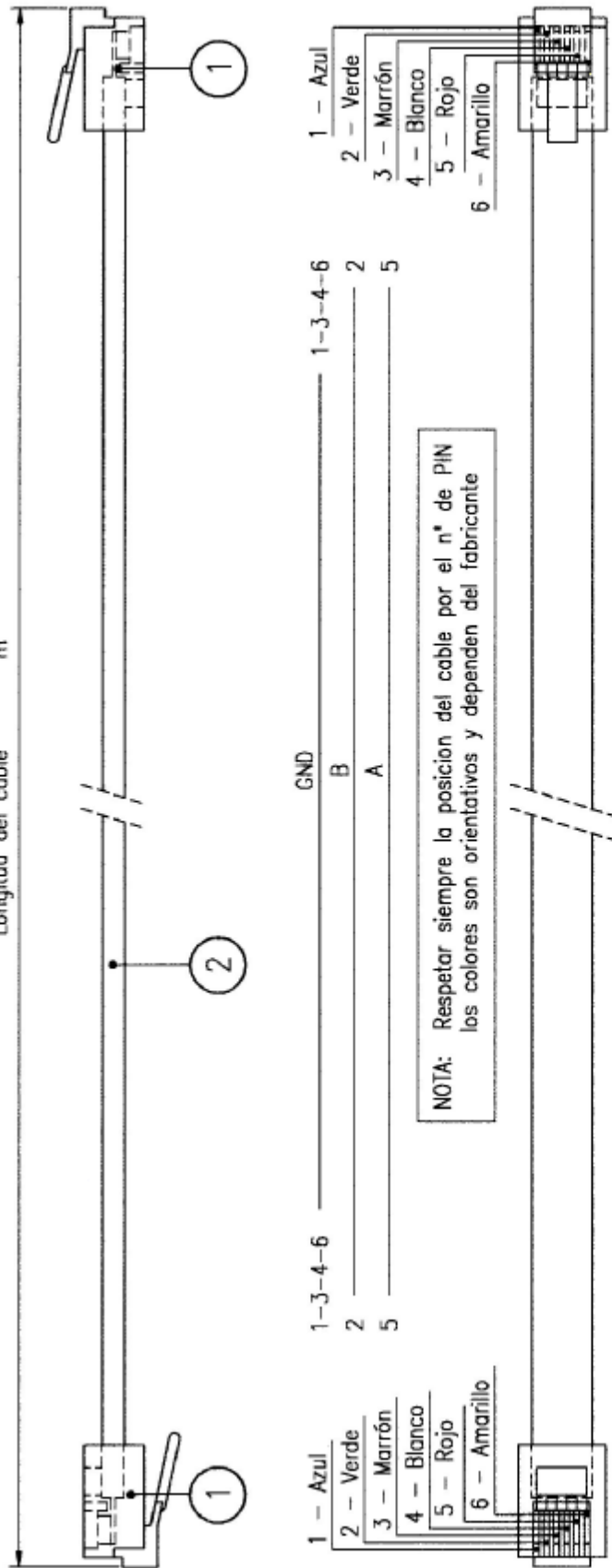

- 1 - Azul
- 2 - Verde
- 3 - Marrón
- 4 - Blanco
- 5 - Rojo
- 6 - Amarillo

NOTA: Respetar siempre la posición del cable por el n° de PIN los colores son orientativos y dependen del fabricante

- 1.- CONECTOR TELEFONICO MACHO MODULAR 6P 6C (RJ11)
CODIGO "ARISTON" C1066
- 2.- CABLE MANGUERA PLANA PARA TELEFONIA 6 VIAS COLOR NEGRO
CODIGO "ARISTON" MT6N 6x6x0,15

1	SE AÑADE NOTA AGRUPACION COLORES DE CABLES	L. Durán	L. Aldes	26-5-00
0				
REV.	MODIFICACIONES	DEBIDO	REVISADO	FECHA
SUSTITUYE A:	SUSTITUIDO POR:	RC.	500-00/01975	CAIFICACION
S/DESPIECE	S/DESPIECE			3B
NO PEZAS	MATERIAL	TRATAMIENTO		MODELO
				BASIC PRINT
COTAS SIN TOLERANCIA		DENOMINACION		
0 < 18	+ 01	CABLE INTERCONEXION ENTRE BALANZAS		
> 18 < 50	+ 02	FECHA	MEMBRE	ESCALA
> 50 < 120	+ 03	DEBIDO	4-5-00	L. Durán
> 120	+ 05	REVISADO	4-5-00	L. ALDES
ANGULOS	RUGOSIDAD	NO PLANO		
° X °	0.1 Ra MAX			
° X °	0.5 Ra MAX			
° X °	1 Ra MAX			
	B Ra MAX			
		REF. 500101975		

Campesa s.a.

Longitud del cable m

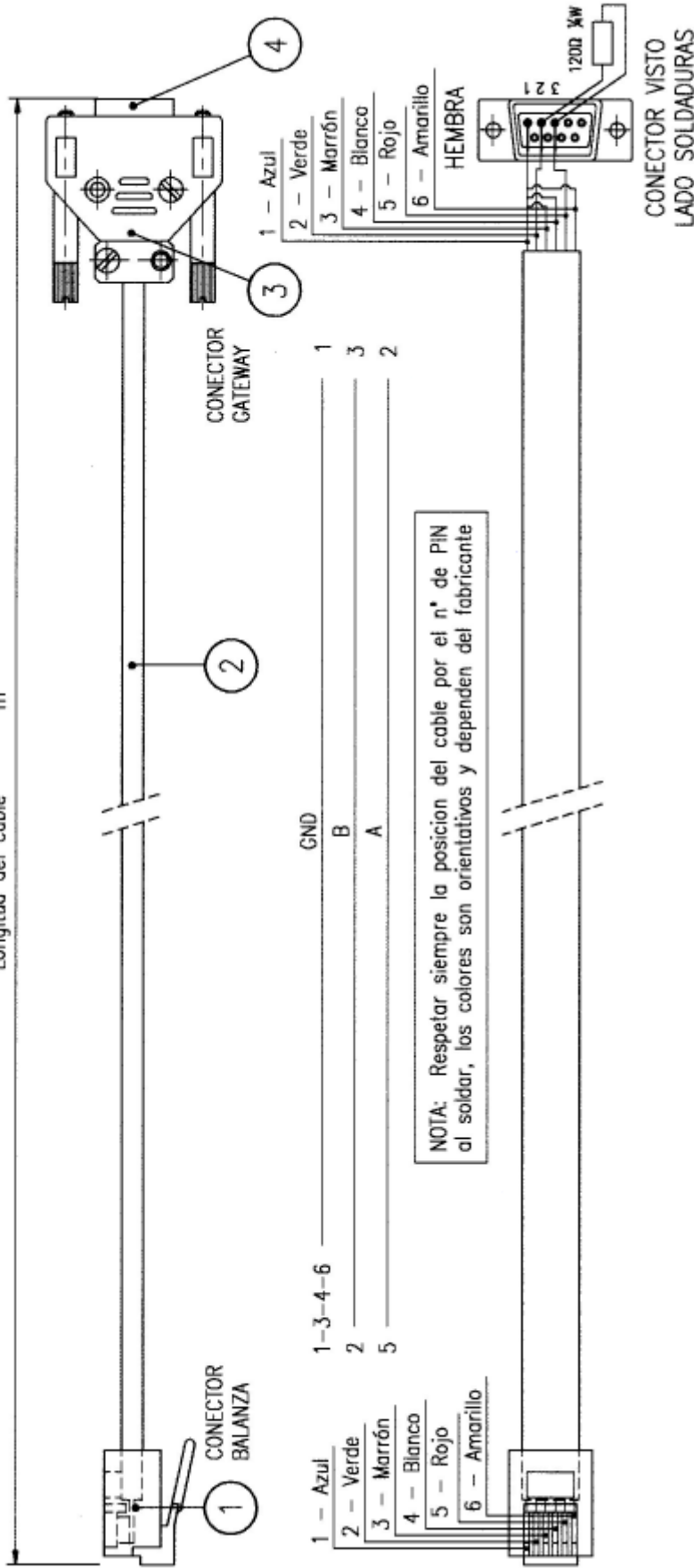

- | | | |
|--------------|---------|---|
| 1 - Azul | 1-3-4-6 | 1 |
| 2 - Verde | 2 | 3 |
| 3 - Marrón | 5 | 2 |
| 4 - Blanco | | |
| 5 - Rojo | | |
| 6 - Amarillo | | |
- GND
B
A

NOTA: Respetar siempre la posición del cable por el n° de PIN al soldar, los colores son orientativos y dependen del fabricante

- Los contactos con cables soldados se protegerán mediante tubo termoretráctil.

- 1.- CONECTOR TELEFONICO MACHO MODULAR 6P 6C (RJ11)CODIGO "ARISTON" CID66
- 2.- CABLE MANCUERA PLANA PARA TELEFONIA 6 VAS COLOR NEGRO CODIGO "ARISTON" MT6N 6x6x0,15
- 3.- CAPERUZA POULAIN 9 CON TORNILLOS
- 4.- CONECTOR POULAIN DN 9 SZ (HEMBRA)

Incluir denominación de conector de Balanza y de Gateway		S.Perez	L.Albes	02-07-01
NY	MODIFICACIONES			
SUSTITUYE A:	SUSTITUIDO POR:	RC.	500-00101922	CAUSACION
				3B
NO PIEZAS	MATERIAL	TRATAMIENTO		
		MODELO		
		AUTONOMA 30		
COTAS SIN TOLERANCIA		DENOMINACION		
0 < 10	+ 0.1	CJTO. CABLE INTERCONEXION		
> 10 < 50	+ 0.2	ENTRE BALANZAS Y GATEWAY (RJ11-DB9)		
> 50 < 100	+ 0.3	FECHA	ESCALA	
> 100	+ 0.5	8-6-00	L. Durán	
ANGULOS	RUGOSIDAD	8-6-00	L. ALDES	
30° ± 0.2	0.1 Ra MAX		NO PLANO	
45° ± 0.3	0.2 Ra MAX		REF. 500101927	
60° ± 0.4	0.3 Ra MAX			
90° ± 0.5	0.4 Ra MAX			
120° ± 0.6	0.5 Ra MAX			

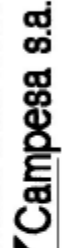

Campesa s.a.

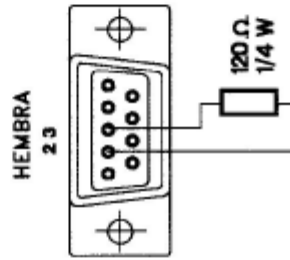
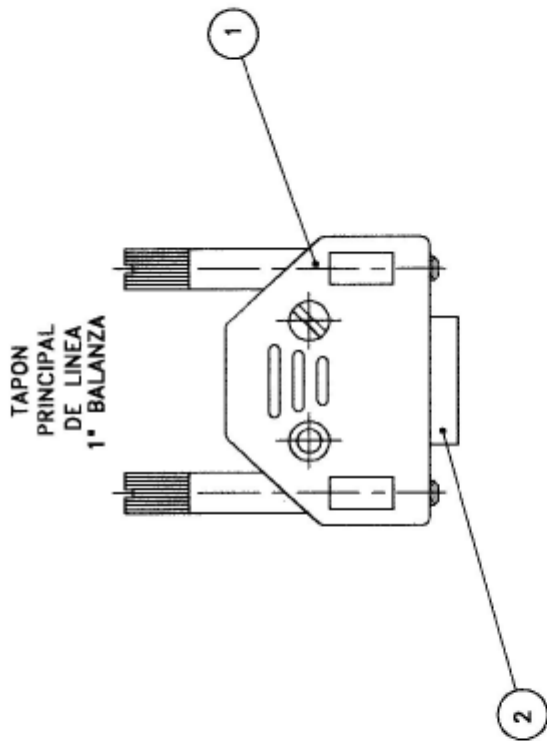

CONECTORES VISTOS POR LADO SOLDADURA

- 1.- 310103009 CAPERUZA POLAIN 9 CON TORNILLOS
- 2.- 310104009 CONECTOR POULAIN DN 9 SZ (HEMBRA)

NV.	MODIFICACIONES		FECHA	NOMBRE
SUSTITUYE A.	SUSTITUIDO POR	RC.	CAIFICACION	
NO PIEZAS	MATERIAL	TRATAMIENTO	MODELO	65710/3 Y HB-510/1
COTAS SIN TOLERANCIA		DENOMINACION	CJTO. CONECTOR 9C. TAPON PRINCIPIO DE LINEA	
0 < 6	± 0.1	FECHA	NOMBRE	ESCALA
> 6 < 10	± 0.2	26-3-98	A. SANROMA	
> 10 < 50	± 0.3	REVISADO	L. ALBES	
> 50 < 100	± 0.5			
> 100	± 1			
ANGULOS	RUGOSIDAD	NO PLANO		
° X °	VVVV 01 Ra MAX			
° X °	VVVV 01 Ra MAX			
° X °	VV 01 Ra MAX			
° X °	VV 01 Ra MAX			
		CampeSA s.a.		REF. 500101742

COM CAMPESA

COM PC

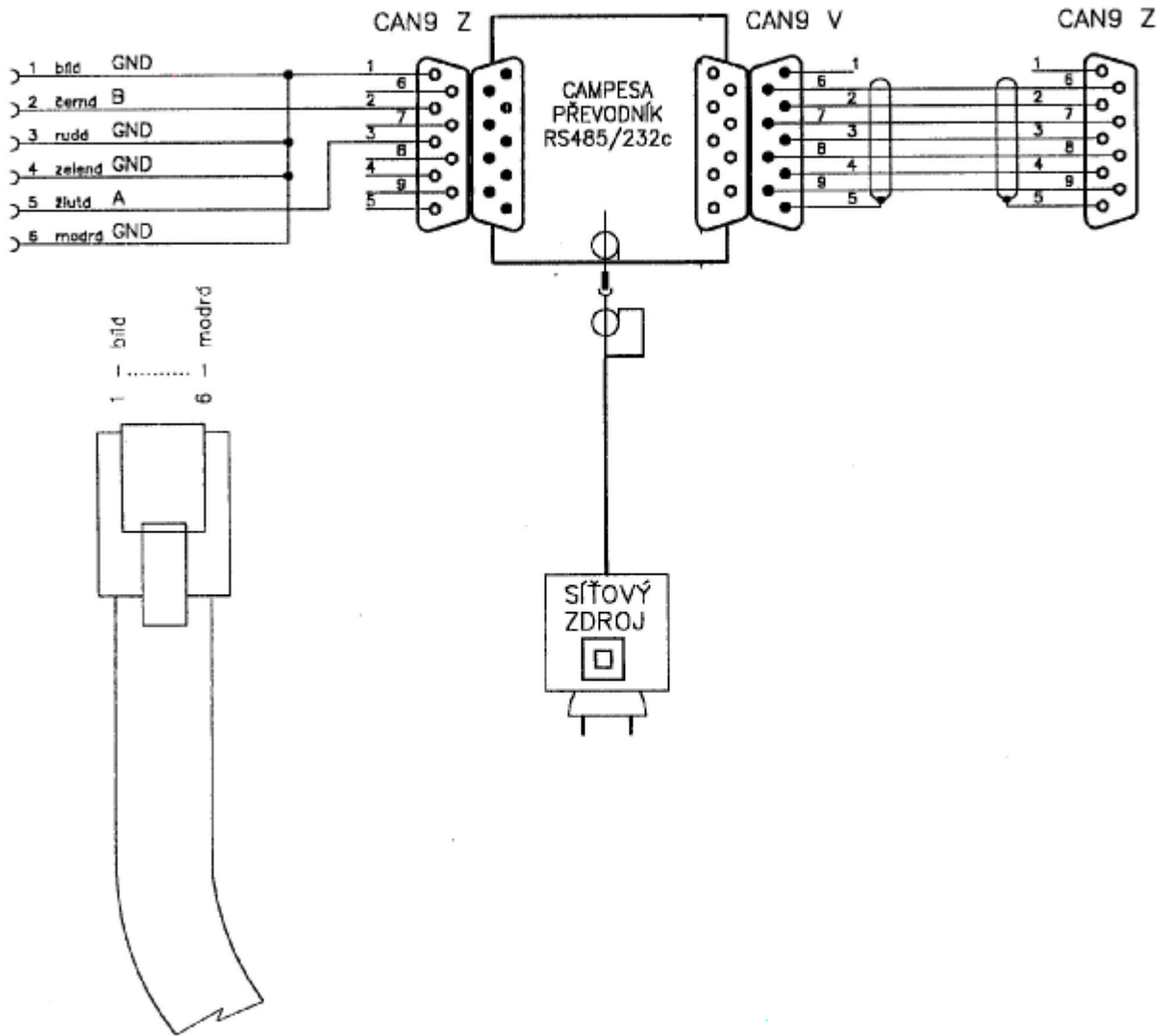

Číslo kusu	Název - rozměr	Polotovary	Mater. konečný	Mater. výchozí	Třída odp.	Č.hmot.	Hr.hmot.	Číslo výkresu	Poz.
Poznámka				Celková čistá hmotnost v kg					
N	Měřička	Kreslil <i>[Signature]</i>	Druh výkr. 7.11.2002	č. snímku	Změna	Datum	Podpis	Index změny	x
	Přezkoušel	Č. n.dwg							x
	Norm. ref.								x
	Výr. projednal	Schválil	č. transp.						x
		Dne							x
	Typ	Skupina		Starý výkres		Nový výkres			
	Název	OBVODOVÉ SCHÉMA KOMUNIKACE RS485/RS232 BASIC - PC			SV94-4A.0068		Počet listů	List	

COM CAMPESA
C03

COM PC

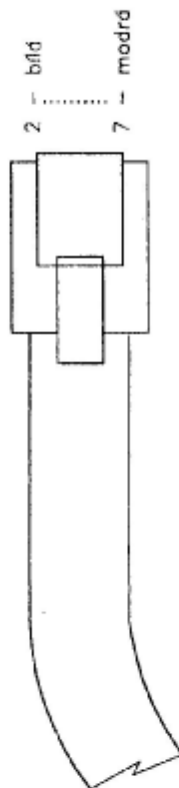
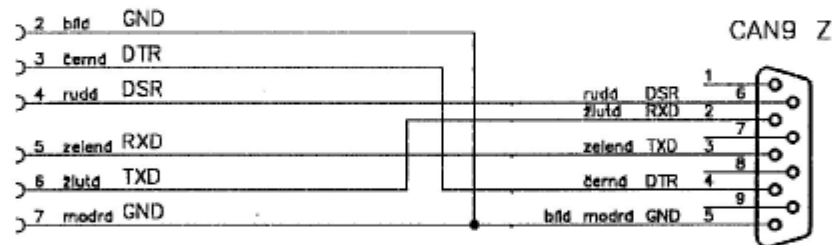

Počet kusů	Název - rozněr	Polotovár	Mater. konečný	Mater. výchozí	Třída odp.	Č.hmot.	H.hmot.	Číslo výkresu	Poz.
Poznámka				Celková čistá hmotnost v kg					
N	Kreslil	<i>[Signature]</i>	Druh výker. 7.11.2002	č. snímku		Změna	Datum	Podpis	Index změny
	Přezkoušel	<i>[Signature]</i>	č. d.wg						
	Norm. ref.								
	Výr. projednal	Schválil	č. transp.						
		Dne							
		Typ	Skupina	Starý výkres		Nový výkres			
Název OBVODOVÉ SCHÉMA KOMUNIKACE RS232 BASIC RK - PC				SV94-4A.0067 Počet listů List					